

Kawasaki

Hydraulics

Product Line Catalog

Kawasaki History

Kawasaki Heavy Industries, Ltd. has been providing technological innovations to the world for more than 100 years. Operating on a global scale, Kawasaki designs, manufactures and markets products ranging from ships, railroad cars, aircraft and motorcycles to industrial plants, steel structures and hydraulic equipment.

Kawasaki Precision Machinery Group is an integral part of Kawasaki. With over 93 years experience in the hydraulics industry, Kawasaki manufactures and markets a wide variety of hydraulic products for mobile, industrial, marine and other applications. Dedicated to global customer support, Kawasaki has operations in Japan, England, Korea, China and the United States. In addition to total commitment toward global customer support, Kawasaki places great emphasis on quality — the hydraulic production facilities in both Japan and England have obtained ISO 9001 and 14001 certification.

Kawasaki Precision Machinery (U.S.A.), Inc, based in Grand Rapids, Michigan, is responsible for technical support, sales and service of Kawasaki Hydraulic Products throughout North and Latin America. Kawasaki's technically oriented staff focuses on understanding and assessing its customers' ever-changing needs. Taking full advantage of Kawasaki's worldwide resources, our staff works closely with factory engineers to provide technical solutions to customers' hydraulic requirements. Through technological leadership and a customer-centered philosophy, Kawasaki Precision Machinery Group has built relationships with top companies around the world who value the high performance and reliability that Kawasaki Hydraulic Products deliver.

A Brief History of Kawasaki's Hydraulic Business

- 1916** Began work on Hele-shaw type radial piston pumps at the marine machinery works (now Kobe Works), formerly Kawasaki Dockyard.
- 1936** Started producing and selling screw pumps.
- 1962** Began producing and selling bent axis type piston pumps/motors.
- 1963** Started producing and selling low speed high torque radial piston motors.
- 1964** Production and sales of hydraulic control valves.
- 1968** Established and relocated to Nishi Kobe Works, started Hydraulic Machinery Division. Developed swash plate type piston pumps/motors.
- 1979** Developed bent axis type piston pumps/motors (L series). Developed swash plate type piston pumps/motors (NV series).
- 1982** Developed piston type medium-speed motors (MX/MB series).
- 1983** Initiated production and sales of bent-axis type piston pumps/motors for open circuits (LVP series).
- 1984** Started sales of two speed motors with built in reduction gear for travel function of construction machinery (DNB series).
- 1987** Renamed the division Precision Machinery Division. Developed mid-speed axial piston motors (M2X series). Developed and commenced sales of swash plate type piston pumps (K3V series).
- 1992** Initiated sales of swash-plate type piston pumps for general industrial machinery (K3VG series).
- 1994** Established Kawasaki Precision Machinery (U.S.A.), Inc., in Grand Rapids, MI, as a sales base in the United States.

Established Kawasaki Precision Machinery (UK) Ltd. and commenced production of Staffa Motors in the UK.

Kawasaki Precision Machinery (UK) Ltd. has been certified by DNV (DET NORSKE VERITAS) to conform to the Quality System Standard ISO 9001.
- 1999** KMC Grand Rapids, MI, facility expansion and renovation completed. Additional 70,000 sq. ft. warehouse and technical facilities to support expanding North American Hydraulics business.
- 2000** Developed North American (SAE) version axial piston pump (K3VL Series).
- 2006** KPM established a production facility in China.
- 2009** Kawasaki Precision Machinery (U.S.A.), Inc. attains ISO 9001 certification.

Kawasaki Facilities



Kawasaki Precision Machinery (U.S.A.), Inc
5080 36th St. S.E., Grand Rapids, MI 49512, U.S.A.
Tel: (616) 949-6500
www.kpm-usa.com



Kawasaki Precision Machinery, Ltd.
Head Office/Main Plant,
234 Matsumoto, Hasetani-Cho,
Nishi-Ku, Kobe 651-2239, Japan
Tel: (81) 78-991-1133
www.khi.co.jp/kpm

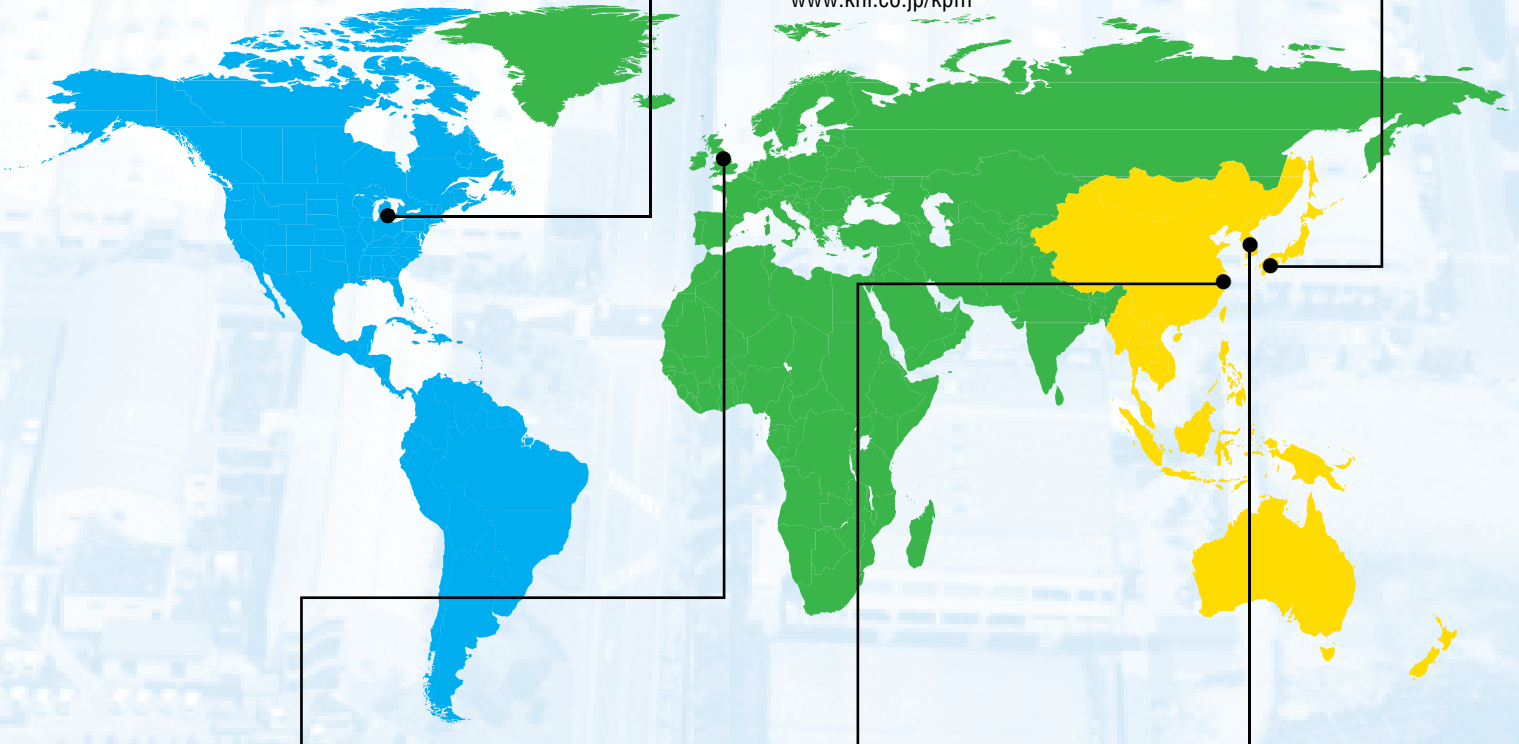

Kawasaki Precision Machinery (UK) Limited
Ernesettle Lane, Ernesettle,
Plymouth, Devon, PL5 2SA England
Tel: (1752) 364394
www.kpm-eu.com



Kawasaki Precision Machinery (Suzhou) Ltd.
9 Guanshan Rd., New District,
Suzhou, 215151 China
Tel: 86-512-6616-0356
www.khi.co.jp/kpm/index_c.html



FLUTEK, Ltd.
192-11, Shin Chon Dong 192-11
Changwon shi, Kyung Nam
Korea
Tel: 82-55-286-5551
www.flutek.co.kr/

Kawasaki Mobile Applications

Hydraulic components and systems from Kawasaki Precision Machinery are used around the world in mobile machinery where high performance and reliability are critical. Mobile vehicles require power, efficiency and steady controlled load movements. Designed to operate under severe conditions, Kawasaki motors, pumps, valves and hydraulic control circuits are rigorously tested and documented before shipment. Mobile equipment operators everywhere depend upon the efficiency and reliability of Kawasaki Hydraulic Products.



Kawasaki **K3V, K5V** and **K7V** axial pumps are widely used on excavators and other larger construction machines. Kawasaki pumps have an excellent global reputation due to their high performance and great quality and reliability. Their spherical valve plate and cylinder block provide excellent balancing capability, assuring maximum efficiency regardless of pressure or flow rate.



The **M5X Series** swash plate type piston motor is equipped with a “shockless” relief valve for precise control. These motors are ideal for swing applications where upper body control is required, such as in large excavators, cranes and forestry machines.

The variable displacement **M3B Series** axial piston hydraulic motor comes in a wide variety of sizes, providing flexibility to meet applications from small to very large crawler cranes and other construction machines. The motor’s spherical valve plate assures good cavitation resistance and high starting efficiency.



The flexible **MW Series** multiple control valves provide stackable valve sections, configured in parallel, series or tandem circuits for precise control of a variety of hydraulic systems.





The new **K3VL Series** pumps are based on the K3V design, where more than 2 million units have been supplied to the mobile industry. The **K3VL Series** pumps were specifically designed for the American and European markets, having SAE and ISO mounting, shaft porting, and through-drive configurations.

PV48 Series joysticks and **RCV Series** foot control valves have become the industry standard in mobile applications. The PV48K features an aluminum body and dual area spool design, which results in light weight and reduced operating torque. The **RCV Series** is available with an internal damping option, which provides excellent stability.

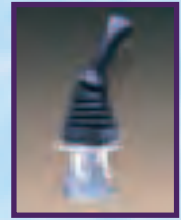

Kawasaki **M3X-RG Series** low speed, high torque hydraulic motors are the right solution for cutters and other large mobile units with high torque demands. A variety of motor sizes and gearboxes provide a wide range of geared high torque motors for heavy duty applications.

Widely used as a winch motor for construction machines such as truck cranes, the compact **M3X Series** hydraulic motor features a built-in mechanical brake to hold the load securely. Built-in relief and make-up valves allow easy installation directly on a gearbox.



Connected directly to the ports of the hydraulic motors, the **KDC Series** counterbalance valve prevents loads from dropping freely and regulates lowering speed smoothly by generating the required back pressure to the winch motor.



Kawasaki Industrial Applications

With hydraulic experience that originated over 93 years ago, Kawasaki remains an industry leader with some of the most technically advanced designs on the market today. Kawasaki's Hydraulic Components are known around the world for providing the high reliability and controllability valued in today's complex industrial environment. Highly advanced hydraulic control systems contribute to productivity improvements by achieving high-speed, precise control of industrial machinery. Superior technology, global acceptance, and proven reliability make Kawasaki Hydraulic Components a leading choice of machine builders for today's innovative applications.



The **K3VL Series** pump is designed for medium to heavy-duty applications where high pressure and low output pulsation are critical. Various control options are available including load-sensing, electronic flow control, torque limiting and integral unloading control.



HMB, HMC & HPC Series Staffa radial piston high-torque low-speed motors offer consistent, controlled acceleration of loads and smooth, steady operation. Direct drives are a preferred solution to combination drives in injection molding machines and other industrial high torque applications. Engineered for long life under demanding loads, Staffa motors provide exceptional starting torque and mechanical efficiency.

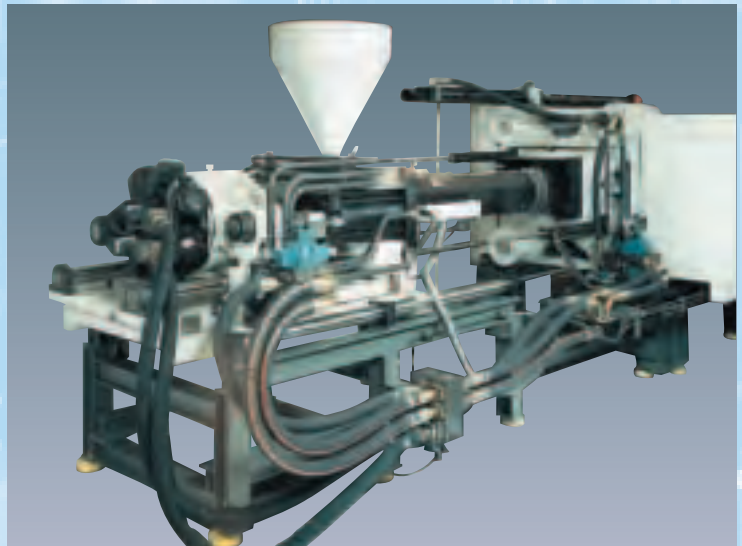



In applications that demand rapid, precise control, the **K3VG Series** hydraulic pump has built-in electronic controls for outstanding controllability.

Electronic pump controls can be actuated by computer to provide integrated control systems for precision, high speed applications such as the test platform shown here. The "ILIS" control module features integral sensors that measure swash plate angle for feedback control to the computer.

Industries that operate around the clock depend upon Kawasaki **K3VG Series** high efficiency axial piston pumps, which use the same internal components as K3V Series pumps to ensure ultra-high reliability. In a steel rolling mill, K3VG pumps supply a continuous flow and steady pressure to cylinders that control the movement of the rollers.



Multiple **M3X Series** axial piston hydraulic motors provide the driving force to turn a giant boring machine efficiently. A special spherical surface type valve plate significantly improves the starting efficiency, enabling the motor to start the machine under full load.

Kawasaki Marine Applications

From small cartridge valves that control a single function to powerful hydraulic motors and pumps with complex multi-valve controls, Kawasaki Hydraulic Components and complete systems are on the job in marine applications around the world. Kawasaki provides supplemental packages for your motor and pump needs. Whether your motor requires a stable brake system or your pump needs a controlled and uniform valve package, Kawasaki's engineered solutions cover a wide variety of marine applications. Because equipment designers demand well-documented performance and reliability when they choose hydraulic components, Kawasaki offers a wide selection of rigorously tested components to fulfill customer needs. With over 93 years of experience in hydraulic technology, Kawasaki remains the choice of industry leaders today.

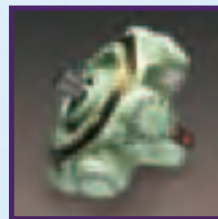

Staffa HMB, HMC & HCP Series radial piston high-torque, low-speed motors meet the needs of applications that demand fine control or have special control requirements. The motor's modular design allows for a variety of valve attachments. It has multi-port surfaces which support several different control valves, such as counterbalance valves for braking pressure in winch drums.

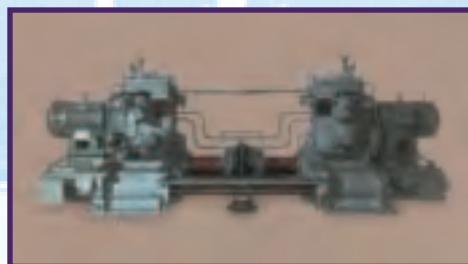

Kawasaki steering gear mechanisms provide hydraulic control of the rudder to guide ocean-going vessels. To provide continuous operation without interruption, a complete back-up system with duplicated electric motors, reservoirs, and pumps are engineered to ensure reliable guidance even if an individual unit fails.



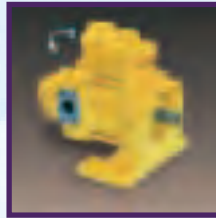

Kawasaki high pressure, long life **K3VL & K3VG Series** hydraulic pumps provide high pressure (4600 & 5000 psi) and continuous driving capability required for applications such as derrick cranes and winches.

For applications such as mooring winches, where reliability and high-torque are required, a **Staffa** high-torque, low-speed radial piston motor coupled with a ring gear offers a simple, economical solution. The motor's hydrostatically balanced connecting rod and valve spool design minimizes internal metal to metal contact, reducing friction for high mechanical efficiency and long life. Staffa motors have demonstrated their reliability in over 55 years of successful operation worldwide.

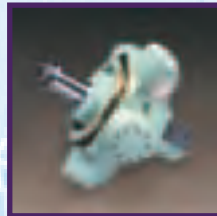

The **M3X Series** fixed displacement swash plate type axial piston motor has high starting efficiency due to its spherical valve plate design. Shaft creep is minimized because of stable retention of the cylinder, enabling the motor to hold a windlass drum steady with minimal slip. **M3B** variable displacement axial piston motors are also widely used in marine winch applications to satisfy various torque and speed requirements.

九神太八十
TAIJIN HARU NEI

Kawasaki Hydraulic Pumps



K3VL pumps are medium pressure, open circuit, axial piston pumps designed for mobile, industrial and marine use.

K3VL Series: Variable Displacement Swash Plate Type Piston Pump

Model	Displacement		Pressure				Speed		Weight	
	cm ³	in ³	psi		bar		rpm		lb	kg
			Rated	Peak	Rated	Peak	Self Prime	Max.		
K3VL28	28	1.71	4600	5075	320	350	3000	3600	44	20
K3VL45	45	2.75	4600	5075	320	350	2700	3250	55	25
K3VL60	60	3.66	3625	4060	250	280	2400	3000	55	25
K3VL80	80	4.88	4600	5075	320	350	2400	3000	77	35
K3VL112	112	6.83	4600	5075	320	350	2200	2700	143	65
K3VL140	140	8.54	4600	5075	320	350	2200	2500	143	65
K3VL200	200	12.20	4600	5075	320	350	1800	2200	209	95



K3VG pumps are high pressure, open circuit, axial piston pumps designed specifically for industrial applications.

K3VG Series: Variable Displacement Swash Plate Type Piston Pump

Model	Displacement		Pressure				Speed		Weight	
	cm ³	in ³	psi		bar		rpm		lb	kg
			Rated	Peak	Rated	Peak	Self Prime	Max.		
K3VG63	63	3.84	5075	5800	350	400	2600	3250	106	48
K3VG112	112	6.83	5075	5800	350	400	2200	2700	150	68
K3VG180	180	11.0	5075	5800	350	400	1850	2300	190	86
K3VG280	280	17.1	5075	5800	350	400	1600	2000	353	160
K3VG180DT	180x2	11.0x2	5075	5800	350	400	1850	2300	353	160
K3VG280DT	280x2	17.1x2	5075	5800	350	400	1600	2000	661	300



K7VG pumps are high pressure open circuit axial piston pumps designed for use in heavy duty industrial applications.

K7VG Series: Variable Displacement Swash Plate Type Piston Pump

Model	Displacement		Pressure				Speed		Weight	
	cm ³	in ³	psi		bar		rpm		lb	kg
			Rated	Peak	Rated	Peak	Self Prime	Max.		
K7VG180	180	11.0	5075	5800	350	400	1800	2200	340	154
K7VG265	270	16.5	5075	5800	350	400	1600	1900	485	220

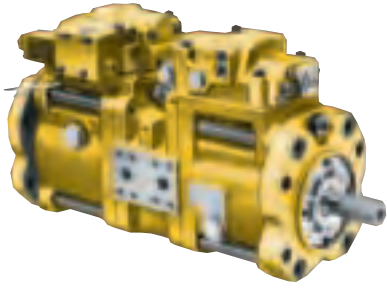

K3V pumps are high pressure open circuit axial piston pumps designed specifically for the earth moving and construction industries where in excess of 2 million units have been supplied.

K3V Series: Variable Displacement Swash Plate Type Piston Pump

Model	Displacement		Pressure				Speed		Weight	
	cm ³	in ³	psi		bar		rpm		lb	kg
			Rated	Peak	Rated	Peak	Self Prime	Max.		
K3V63DT	63x2	3.84x2	4970	5680	343	392	2650	3250	179	81
K3V112DT	112x2	6.83x2	4970	5680	343	392	2360	2700	276	125
K3V140DT	140x2	8.54x2	4970	5680	343	392	2150	2500	353	160
K3V180DT(H)	180x2	11.0x2	4970	5680	343	392	1950	2300	353	160
K3V280DTH	280x2	17.1x2	4970	5680	343	392	2000	2000	595	270

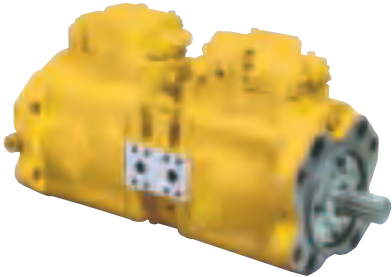

K5V pumps are high pressure open circuit axial piston pumps designed with increased swash-plate angle resulting in higher power density (compactness).

K5V Series: Variable Displacement Swash Plate Type Piston Pump

Model	Displacement		Pressure				Speed		Weight	
	cm ³	in ³	psi		bar		rpm		lb	kg
			Rated	Peak	Rated	Peak	Self Prime	Max.		
K5V80DT	80x2	4.88x2	4970	5680	343	392	2460	3000	179	81
K5V140DT	140x2	8.54x2	4970	5680	343	392	2160	2500	276	125
K5V160DT	160x2	9.76x2	4970	5680	343	392	2000	2350	353	160
K5V200DT(H)	200x2	12.2x2	4970	5680	343	392	1900	2200	353	160

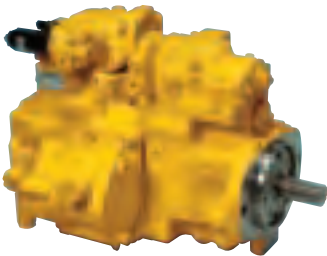

K7V pumps are high pressure open circuit axial piston pumps specially designed with shortened length for compact machine installation requirements.

K7V Series: Variable Displacement Swash Plate Type Piston Pump

Model	Displacement		Pressure				Speed		Weight	
	cm ³	in ³	psi		bar		rpm		lb	kg
			Rated	Peak	Rated	Peak	Self Prime	Max.		
K763DT	63x2	3.84x2	5075	5800	350	400	2600	3250	190	86

Kawasaki Hydraulic Motors



The Staffa HMB high torque, low speed, fixed displacement, radial piston motor is designed for rigorous industrial and mobile applications.

HMB Series: Fixed Displacement, High Torque, Low Speed, Radial Piston Type Motor

Model	Displacement		Pressure				Speed rpm Max	Rated Torque		Weight	
	in3	cm3	psi		bar			lb-ft	N-m	lb	kg
HMB010	11.5	188	3000	3500	207	240	500	426	578	88	40
HMB030	27	442	3000	4250	207	293	450	1002	1359	161	73
HMB045	45.2	740	3625	4250	250	293	400	2019	2738	265	120
HMB060	60	983	3625	4250	250	293	300	2683	3638	317	144
HMB080	82.0	1344	3625	4250	250	293	300	3661	4964	317	144
HMB100	100.0	1639	3625	4250	250	293	250	4459	6046	317	144
HMB125	125.0	2050	3625	4250	250	293	220	5655	7668	478	217
HMB150	151.0	2470	3625	4250	250	293	220	6808	9232	584	265
HMB200	188.0	3080	3625	4250	250	293	175	8493	11517	584	265
HMB270	263.0	4310	3625	4250	250	293	125	11756	15941	926	420
HMB325	324.0	5310	3625	4250	250	293	100	14645	19859	946	429
HMHDB400	415.0	6800	3625	4250	250	293	120	18669	25315	1060	481
HMB700	708.0	11600	3000	3625	207	250	100	26644	36129	2315	1050



The Staffa HMC high torque, low speed, dual displacement motor is designed for rigorous industrial applications where dual or continuous displacement is required.

HMC Series: Dual Displacement, High Torque, Low Speed, Radial Piston Type Motor

Model	Displacement				Pressure				Max. Speed		Rated Torque				Weight	
	in3		cm3		psi		bar		rpm		lb-ft		N-m		lb	kg
HMC030	6.0	30	98	492	3000	3500	207	240	450	600	1047	174	1420	236	220	100
HMC045	9.9	45	153	737	3625	4000	250	275	450	600	1965	279	2665	378	331	150
HMC080	10.0	97.6	164	1600	3625	4000	250	275	300	600	4060	290	5505	393	379	172
HMC125	10.0	125	164	2048	3625	4000	250	275	190	600	5510	109	7472	148	516	234
HMC200	9.8	188	160	3080	3625	4000	250	275	175	600	8591	109	11649	148	622	282
HMC270	20.0	280	328	4588	3625	4000	250	275	120	350	12796	435	17351	590	992	450
HMC325	95.0	325	1557	5326	3625	4000	250	275	100	350	14826	3843	20104	5211	1014	460

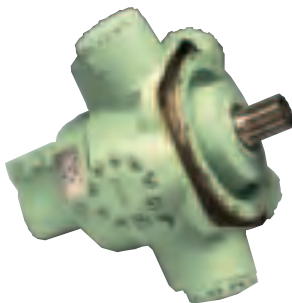

The Staffa HPC series is a high power version of the HMC Series, for high performance applications.

HPC Series: Dual Displacement, High Power, Radial Piston Type Motor

Model	Displacement				Pressure				Max. Speed		Rated Torque				Weight	
	in3		cm3		psi		bar		rpm		lb-ft		N-m		lb	kg
HPC080	10	97.6	164	1600	3625	3625	250	250	365	630	4444	295	6025	400	379	172
HPC125	20	125	328	2048	3625	3625	250	250	300	630	5679	756	7700	1025	516	234
HPC200	20	188	328	3087	3625	3625	250	250	230	630	8703	774	11800	1050	622	282
HPC270	20	280	328	4588	3625	3625	250	250	545	150	12926	738	17525	1000	992	450
HPC325	30	325	492	5326	3625	3625	250	250	515	130	15046	1162	20400	1575	1014	460



K3X Series: Fixed Displacement Axial Piston Type Motor

Model	Displacement		Pressure				Speed rpm (HP*)	Rated Torque		Weight	
	cm3	in3	psi		bar			lb-ft	N-m	lb	kg
			Rated	Max.	Rated	Max.					
K3X63	63	3.84	4550	5000	314	345	3000	236	320	51	23
K3X80	82	5.00	4550	5000	314	345	3000	302	410	88	40
K3X90	89	5.43	4550	5000	314	345	3000	329	446	88	40
K3X112	111	6.83	4550	5000	314	345	3000	409	554	88	40

The K3X fixed displacement axial piston motor is a small, compact motor designed for mid and high speed applications.

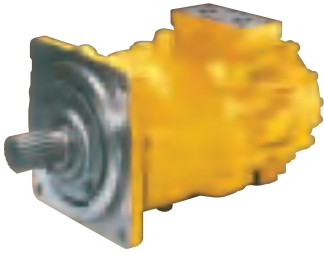

M3X Series: Fixed Displacement Axial Piston Type Motor

Model	Displacement		Pressure				Speed rpm Max.	Rated Torque		Weight	
	cm3	in3	psi		bar			lb-ft	N-m	lb	kg
			Rated	Max.	Rated	Max.					
M3X200	195	11.9	4300	5000	294	343	1900	671	910	93	42
M3X280	280	17.1	4300	5000	294	343	1700	966	1310	137	62
M3X530	533	32.5	4300	5000	294	343	1400	1840	2500	199	90
M3X800	800	48.8	4300	5000	294	343	1200	2760	3750	294	133

These multi-purpose motors are available in a wide range of fixed displacements. Optional integral mechanical static brakes are available.

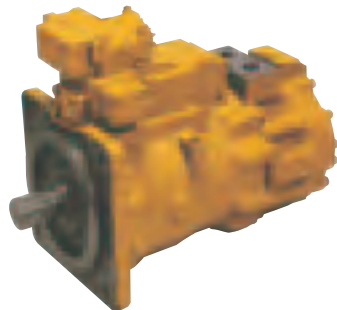

M3B Series: Dual Displacement Axial Piston Type Motor

Model	Displacement						Pressure				Speed rpm	Rated Torque		Weight		
	cm3		in3		psi		bar		100%	50%/33%		lb-ft	N-m	lb	kg	
	100%	50%	33%	100%	50%	33%	Rated	Max.	Rated	Max.						
M3B200	195	106	—	11.9	6.47	—	4600	5000	320	350	1900	2930	730	990	159	72
M3B280	280	140	93	17.1	8.5	5.7	4350	5000	300	350	1700	2200	988	1340	205	93
M3B530	533	267	178	32.5	16.3	10.9	4250	5000	294	343	1400	1700	1840	2500	324	147
M3B800	800	400	267	48.8	24.4	16.3	4250	5000	294	343	1200	1500	2760	3750	518	235

These multi-purpose motors are available in a range of dual and continuous displacements. Optional integral mechanical static brakes are available.

Kawasaki Hydraulic Motors

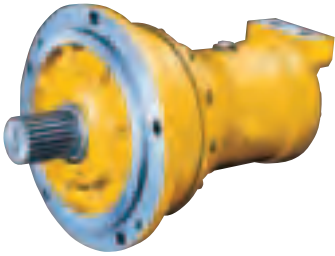

M Series motors are available with reduction gear for applications requiring multiplied torque at lower speeds.

M3X/M3B-RG Series: Fixed/Variable Displacement Axial Piston Geared Type Motor

Model	Displacement		Pressure		Speed rpm Max.	Rated Torque		Weight	
	cm3	in3	psi Max.	bar Max.		lb-ft	N-m	lb	kg
M3X200-RG03S5.7	840	51.3	3200	225	270	2161	2930	216	98
M3X280-RG06S6.4	1610	98.2	3000	207	190	3894	5280	331	150
M3B280-RG06S6.4	1610	98.2	3000	207	190	3894	5280	331	150
M3X530-RG11S5.7	3010	183.7	3000	207	150	7280	9870	536	243
M3B530-RG11S5.7	3010	183.7	3000	207	150	7280	9870	536	243
M3X800-RG16S6.4	5120	312.4	2800	197	130	11801	16000	926	420
M3B800-RG16S6.4	5120	312.4	2800	197	130	11801	16000	926	420



The M2X and M5X fixed displacement axial piston motors are specifically designed for excavator swing operation.

M2X/M5X Series: Fixed Displacement Axial Piston Type Motor

Model	Displacement		Pressure		Speed rpm Max.	Rated Torque		Weight	
	cm3	in3	psi Rated	psi Max.		bar Rated	bar Max.	lb-ft	N-m
M2X63	64	3.91	4260	4970	2200	221	300	64	29
M5X130-121	122	7.44	4970	5970	1850	490	665	104	47
M5X130	129	7.87	4700	5680	1850	494	670	104	47
M5X180-169	169	10.3	4970	5970	1680	679	921	135	61
M5X180	180	11.0	4700	5680	1680	687	932	135	61
M2X210	210	17.1	4260	4970	1400	723	980	146	66



M2X Series motors are available with reduction gear.

M2X/M5X-RG Series: Fixed Displacement Axial Piston Geared Type Motor

Model	Displacement		Pressure		Speed rpm Max.	Rated Torque		Weight	
	cm3	in3	psi Max.	bar Max.		lb-ft	N-m	lb	kg
M2X63CHB-RG06D	1230	75.1	4000	276	115	3980	5400	229	104
M5X130CHB-RG11D	2590	158	3770	260	92	7890	10700	478	217
M5X130CHB-RG14D	2590	158	4700	324	92	10180	13800	617	280
M5X180CHB-RG14D	3400	207	3700	255	84	10180	13800	637	289
M5X180CHB-RG20D	4540	277	4161	287	67	15270	20700	924	419

Kawasaki Rotary Actuators



HR Series rotary actuators are suitable for applications requiring limited rotation.

HR Series: Rotary Actuator

Model	Displacement				Pressure		Rotating Angle deg	Rated Torque		Weight	
	Per Radian cm ³	in ³	Total Travel cm ³	in ³	psi Rated	bar Rated		lb-ft	N-m	lb	kg
HR-08S-04	20.8	1.3	102	6.2	2000	138	280	166	225	15	7
HR-11S-06	57.3	3.5	280	17.1	2000	138	280	463	628	37	17
HR-15S-08	154.0	9.4	753	46.0	2000	138	280	1266	1717	77	35
HR-20S-10	438.0	26.7	1450	88.5	2000	138	190	3544	4806	198	90
HR-20S-18	755.0	46.1	2500	153.0	1000	69	190	2929	3972	231	105
HR-08D-04	41.6	2.5	73	4.5	2000	138	100	376	510	18	8
HR-11D-06	115.0	7.0	200	12.2	2000	138	100	1049	1422	40	18
HR-15D-08	308.0	18.8	538	32.8	2000	138	100	2821	3825	82	37

Kawasaki Remote Control Valves



PV Series: Hydraulic Type Joystick Pilot Valve (for Mobile Usage)

Model	Max. Inlet Pressure		Outlet Pressure Metering Range		Max. Back Pressure		Max. Cont. Flow		Lever Angle deg	Actuation Torque	
	psi	bar	psi	bar	psi	bar	GPM	l/min		lb-ft	N-m
PV48K	1,000	69	0 ~ 420	0 ~ 29	40	2.8	5.3	20	±25	2.8	3.8
PV48M	1,000	69	0 ~ 420	0 ~ 29	40	2.8	4	15	±25	2.8	3.8
PV6P	1,000	69	0 ~ 420	0 ~ 29	40	2.8	2.6	10	±23	9.0	12.2
PVD6P	1,000	69	0 ~ 420	0 ~ 29	40	2.8	2.6	10	±12.4	6.34	8.6
PVD8P	1,000	69	0 ~ 420	0 ~ 29	40	2.8	2.6	10	±12.4	13.2	17.9

The PV48K and PV48M are four-way (dual axis), hand operated, joystick type pilot valves. These valves feature a cast aluminum body and dual area spool design, having light weight and reduced lever input force. The PV6P is a two-way (single axis) joystick pilot valve.



RCV Series: Hydraulic Type Foot Control Pilot Valve (for Mobile Usage)

Model	Max. Inlet Pressure		Outlet Pressure Metering Range		Max. Back Pressure		Max. Cont. Flow		Lever Angle deg	Actuation Torque	
	psi	bar	psi	bar	psi	bar	GPM	l/min		lb-ft	N-m
RCV8C	1420	98	640	44.2	40	2.8	4	15	±12.4	13.2	17.9

The RCV8C is a foot operated, pedal type remote-control valve developed specifically for the mobile hydraulics industry. This valve is available in a 1 or 2-section or 2-function mono-block (2-way each) configuration.



ERU Series: Electronic Type Joystick Pilot Valves (for Mobile Usage)

Model	Description	Current Output			Voltage Output		Lever Angle deg	Actuation Torque	
		Input	Output	PWM	Input	Analog		lbt-ft	N-m
ERU2	Dual Axis Joystick	7.6-12.6vdc	500 Hz	25mA	4.5-5.6 vdc	5vdc	±23	1.8	2.4
ERUS	Single lever	7.6-12.6vdc	500 Hz	25mA	4.5-5.6 vdc	5vdc	±21.5	1.8	2.4
ERUH	Modulation Handle	7.6-12.6vdc	500 Hz	25mA	4.5-5.6 vdc	5vdc	—	—	—

ERUP Series: Electronic Type Foot Control Pilot Valves (for Mobile Usage)

ERUP1	Single Pedal Type	7.6-12.6vdc	500 Hz	25mA	4.5-5.6 vdc	5vdc	±12.4	11.3	15.3
ERUP2	Dual Pedal	7.6-12.6vdc	500 Hz	25mA	4.5-5.6 vdc	5vdc	±12.4	11.3	15.3

The ERU and ERUP Series have the same look, feel, and proven performance as our hydraulic pilot valves. The foot operated units are available as single or dual pedal configuration. All of the ERU units feature a reliable and long life non-contact type potentiometer. The body of the ERU is constructed with a heavy duty water proof and electromagnetic noise resistant housing. The ERU controllers can be specified with voltage or current outputs. The ERUH modulation handle features a non-contact type sliding thumb switch, which can control a proportional solenoid directly.



Kawasaki Main Control Valves



KMC Series: Proportional Multiple Control Valves (Sectional Type)

Model	Max. Flow		Max. Pressure		Weight (2 Sections)	
	l/min.	gpm	bar	psi	kg	lb
KMC10	80	21.1	309	4480	20	44

Applicable to various mobile machines including fork-lift trucks and manlifts. Parallel or tandem circuits available. The internal pilot system eliminates external pilot pressure source requirements. Optional valves such as port relief valves available.

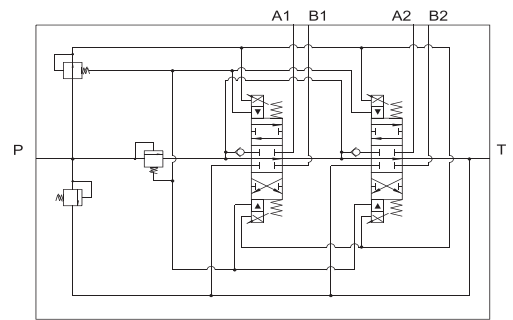

KMP Series: Proportional Multiple Control Valves (Sectional Type)

Model	Max. Flow		Max. Pressure		Weight (2 Sections)	
	l/min.	gpm	bar	psi	kg	lb
KMP10	80	21.1	310	4,500	20	44

Sectional type proportional control valve with pressure compensator and internal pilot supply for electro-hydraulic control of various mobile vehicles. Has manual lever actuation for emergency operation. Very high controllability allowing precise inching operation.

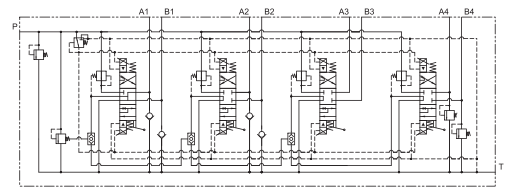

MW Series: Multiple Control Valves (Sectional Type)

Model	Max. Flow		Max. Pressure		Weight (4 Sections)	
	l/min.	gpm	bar	psi	kg	lb
MW25	240	63.4	343	4975	75	165
MW28	350	92.5	343	4975	126	278

Sectional type with parallel, series, tandem or combination of these in one unit. Manual or hydraulic pilot control options available. Suitable for mobile applications. A combination of a remote control valve and a variable displacement pump attains an energy saving circuit for improved efficiency.

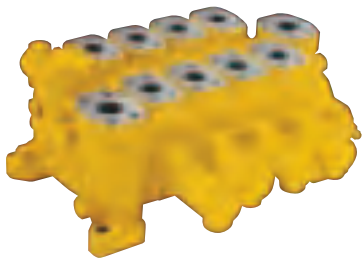
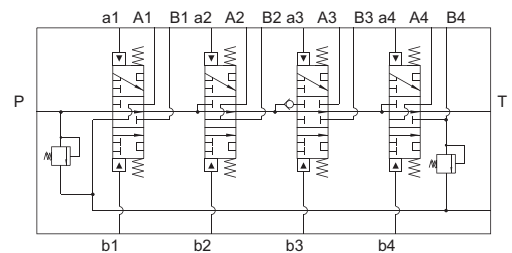

KMX Series: Multiple Control Valves (Semi-monoblock Type)

Model	Max. Flow		Max. Pressure		Weight	
	l/min.	gpm	bar	psi	kg	lb
KMX13	130	34.3	343	4975	160	353
KMX15	240	63.4	343	4975	210	463
KMX32	360	95.1	343	4975	340	750

Multiple semi-monoblock type valves for precise control of actuators. Excellent for mobile excavator-type applications. Special functions include straight traveling and swing priority, etc. A combination of a remote control valve and a variable displacement pump attains energy saving systems, such as a negative control system and a positive control system.



Kawasaki Hydraulic Valves

Solenoid-Operated Control Valves

* KWE5G Series: Monoblock Type Multiple Series



Model	Max. Flow		Max. Pressure		Weight (3 Sections)	
	l/min.	gpm	bar	psi	kg	lb
KWE5	16	4.2	90	1300	4	9

Monoblock design for directional control valve and/or proportional pressure-reducing valve. Splashproof design suitable for mobile applications. The monoblock design features a compact size, simple piping (common P port & T port for all valves), and carry-over port (enabling usage as a hydraulic power source for other circuits).

* Number of sections

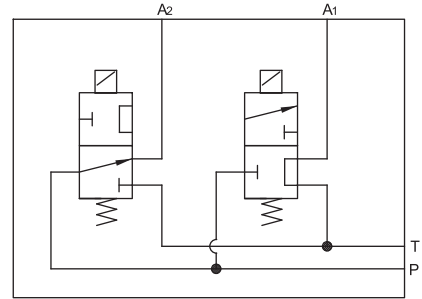

KDRDE & KWE5K Series: Solenoid-Operated Valves

KDRDE5K Pressure Reducing Valve (Cartridge Type) KWE5K Directional Control Valve (Cartridge Type)



Model	Max. Flow		Max. Pressure		Weight	
	l/min.	gpm	bar	psi	kg	lb
KDRDE5K	10	2.6	90	1300	0.4	1
KWE5K	16	4.2	90	1300	0.4	1

Solenoid-operated proportional pressure-reducing valve and directional control valve which are primarily used in pilot circuits for controlling spools of multiple control valves and tilting angles of variable displacement pumps. Features include a compact design and ease of service. Installation cavity common for proportional pressure-reducing valve and directional control valve.

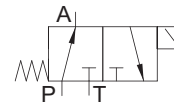
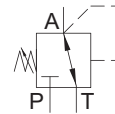

Kawasaki Hydraulics – National Service Center

Grand Rapids, Michigan

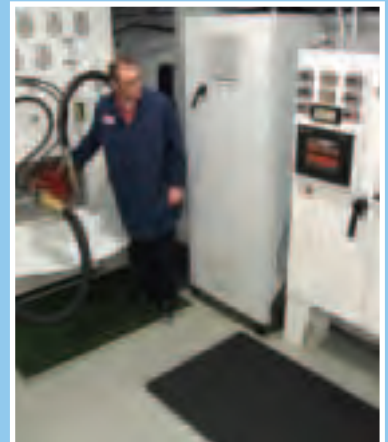

Kawasaki's National Service Center (NSC) is dedicated to providing service support for Kawasaki Hydraulic Products in North & Latin America. Established in 1994, the NSC was designed by factory engineers to specialize in repair, remanufacturing, product conversion, and failure analysis for Kawasaki's hydraulic components. Our factory trained technicians provide high quality workmanship utilizing genuine Kawasaki parts. Prior to shipment, all products are dynamically tested, inspected, and painted, and are covered by Kawasaki's standard warranty.

**Kawasaki Hydraulics
National Service Center
5080 36th Street
Grand Rapids, MI 49512**

**For service inquiries,
please contact us at
616-949-6500**



Kawasaki
Hydraulics



Kawasaki Precision Machinery (U.S.A.), Inc.
5080 36th Street S.E., Grand Rapids, MI 49512
(616) 949-6500 • Fax (616) 975-3103
www.kpm-usa.com

Kawasaki

Hydraulics